

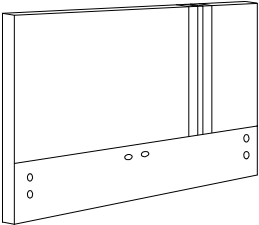

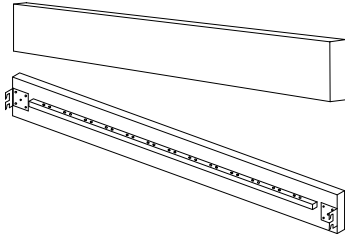

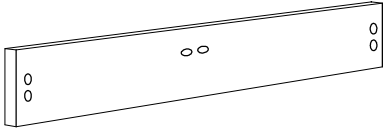

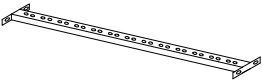

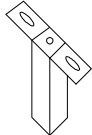

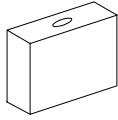
ASSEMBLY INSTRUCTION

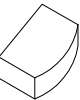
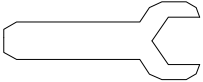
0043. JN177

IMPORTANT NOTE: *PLACE ALL PARTS ON A CLEAN AND SMOOTH SURFACE SUCH AS A RUG OR CARPET TO AVOID THE PARTS FROM BEING SCRATCHED.
*KINDLY FOLLOW THE ASSEMBLY INSTRUCTIONS STEP BY STEP.
*DO NOT TIGHTEN ALL SCREWS UNTIL THE BED IS FULLY SET-UP.

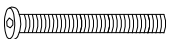
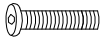

<p>① Headboard-1pc</p> 	<p>② Side Rail-2pcs</p> 	<p>③ Footboard-1pcs</p> 			
<p>④ Support Bar-1pcs</p> 	<p>⑤ Support Leg-2pcs</p> 	<p>⑥ Slats-30pcs</p> 	<p>⑦ Leg 4pcs</p> 	<p>⑧ Center Plastic Connector-15pcs</p> 	<p>⑨ End Cap-30pcs</p> 
<p>A Spanner-1pcs</p> 	<p>B Spring Washer-8pcs</p> 	<p>C Flat Washer-12pcs</p> 	<p>D Allen Key-1pcs</p> 		
<p>E Bolt M8*80mm-4pcs</p> 	<p>F Bolt M8*38mm-16pcs</p> 	<p>G Nut-4pcs</p> 	<p>PAGE 1 OF 2</p>		

1 STEP1:FIXING LEGS TO HEADBOARD AND FOOTBOARD.

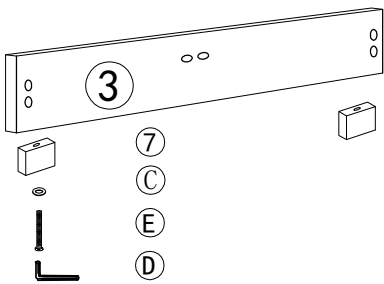
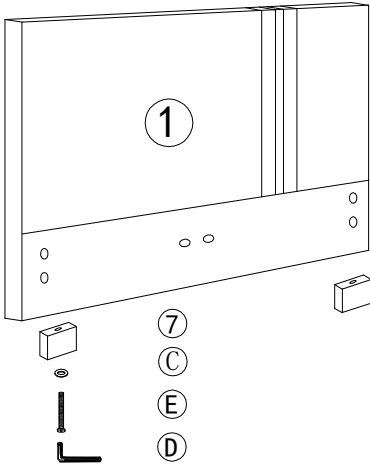

2 STEP2:FIXING METAL LEGS TO CENTRAL METAL TUBE

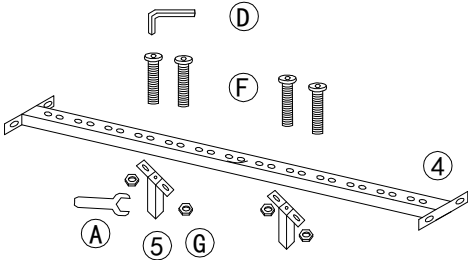

3 STEP3:FIXING SIDEBOARD TO HEADBOARD AND FOOTBOARD

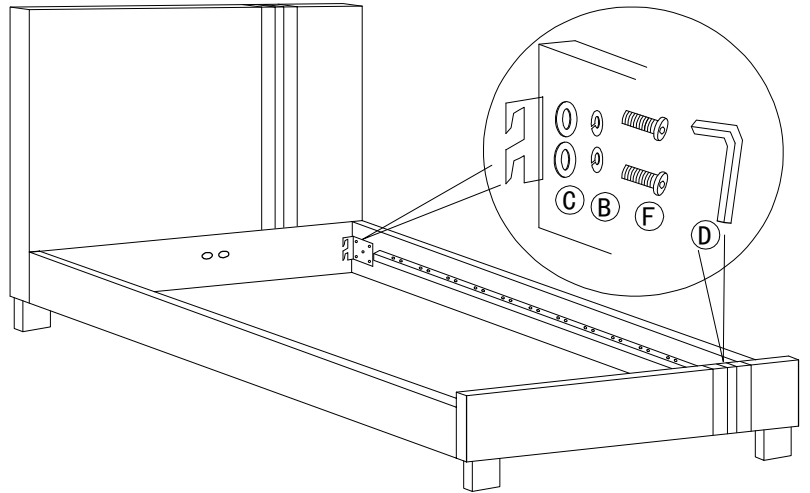

4 STEP4:FIXING CENTRAL SUPPORT METAL TUBE TO BED FRAME

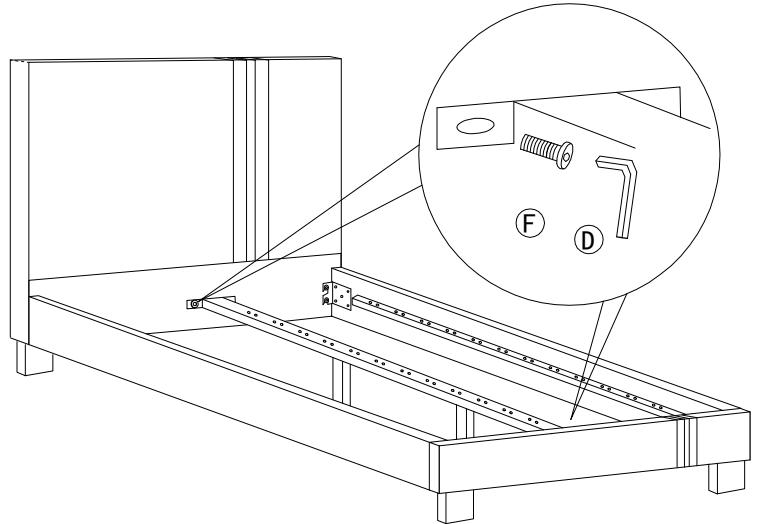

5 STEP 5: FIXING SLATS TO BEDSTOCK.

